

 **blum**®

Lo que necesitas saber para elegir
HERRAJES BLUM



Contenido

1. Sistemas de bisagras

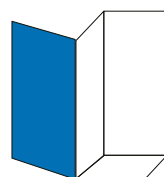

2. Sistemas de compases abatibles AVENTOS

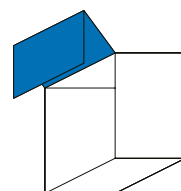

3. Sistemas BOX



4. Sistemas de guías



5. Sistemas de organización

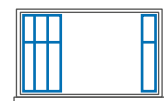

7. Sistemas pocket







8. Productos personalizables



Cómo elegir un PRODUCTO BLUM

Tecnologías de movimiento Blum

(Opciones de apertura de muebles)

		 Puertas	 AVENTOS	 Sistemas BOX	 Sistemas de guías
BLUMOTION by Blum	Cierre suave y silencioso	●	●	●	●
TIP-ON by Blum	Apertura mecánica tipo "push" (Presiona y abre)	●	●*	●*	●*
TIP-ON BLUMOTION by Blum	Apertura mecánica con cierre suave			●*	●*
SERVO-DRIVE by Blum	Apertura eléctrica con cierre suave	●*	●*	●*	●*

*Revisar en qué líneas de producto aplican las tecnologías de movimiento.

Información de limpieza

Los herrajes de Blum están diseñados para poder ser disfrutados durante toda la vida del mueble. Para contribuir a que se pueda realizar su limpieza del modo más fácil posible, te ofrecemos unos cuantos consejos útiles:

Limpia con un trapo de microfibra semi-húmedo

Seca siempre a continuación

Evita utilizar productos de limpieza

Evita almacenar productos de limpieza abiertos

Cómo elegir: Bisagras

*La siguiente variedad de productos, corresponden a los herrajes disponibles en Blum México (2026)

Espesor máximo de frente

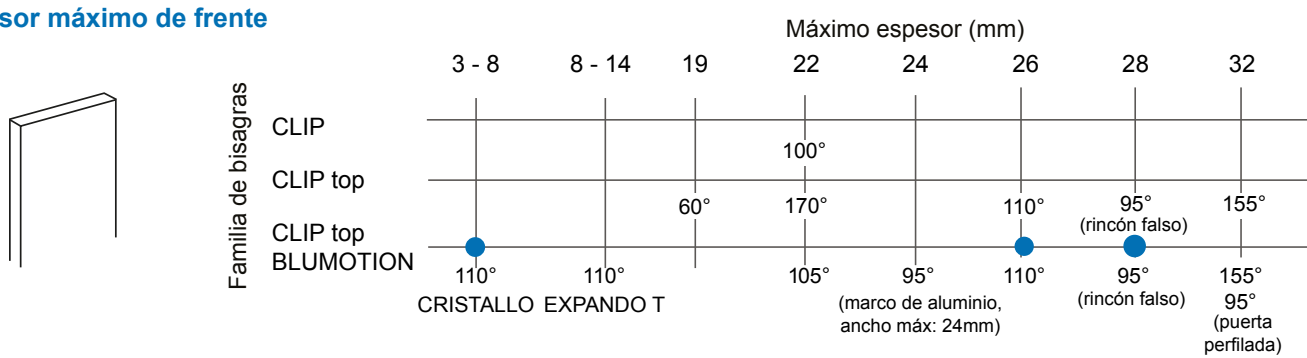

Tecnologías de movimiento



Cierre suave
Bisagras con muelle



Apertura mecánica para frentes sin jaladeras
Bisagras sin muelle

CLIP top BLUMOTION

95° rincón falso
95° puerta perfilada
95° marco de aluminio
*BLUMOTION integrado

No aplica
Excepto para aplicación de TIP-ON con goma

CLIP top

95°* marco de aluminio estrecho
105°**
110°
170°
*BLUMOTION como accesorio
**No existe BLUMOTION como accesorio

105°
110°
155°
110° CRISTALLO
110° EXPANDO T

CLIP

100°
*BLUMOTION como accesorio

100°

Sujeción recomendada por tipo de material de frente

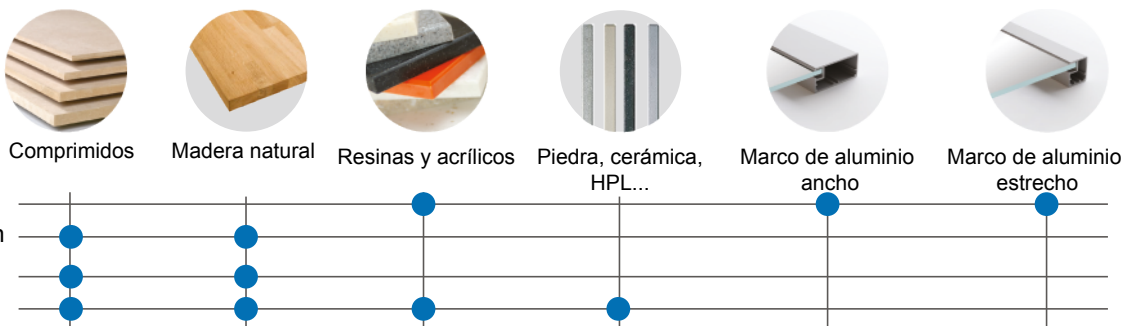

Limitadores de apertura

85° 94M2553
CLIP top BLUMOTION 105°

86° 70T3553
CLIP top 110°
CLIP top BLUMOTION 110°

92° 70T7553.09
CLIP top 155°
CLIP top BLUMOTION 155°

92° 70T4503.09
CLIP top EXPANDO T y CRISTALLO
CLIP top BLUMOTION EXPANDO T y CRISTALLO

Situación de montaje

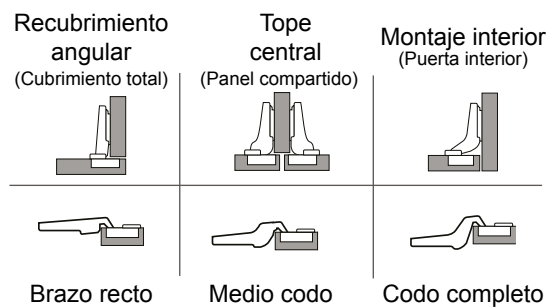

Cantidad de bisagras por puerta

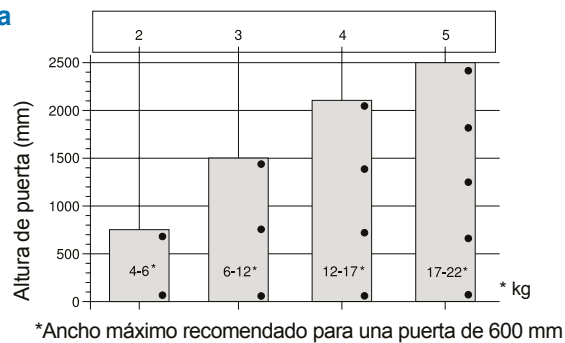

Aplicaciones

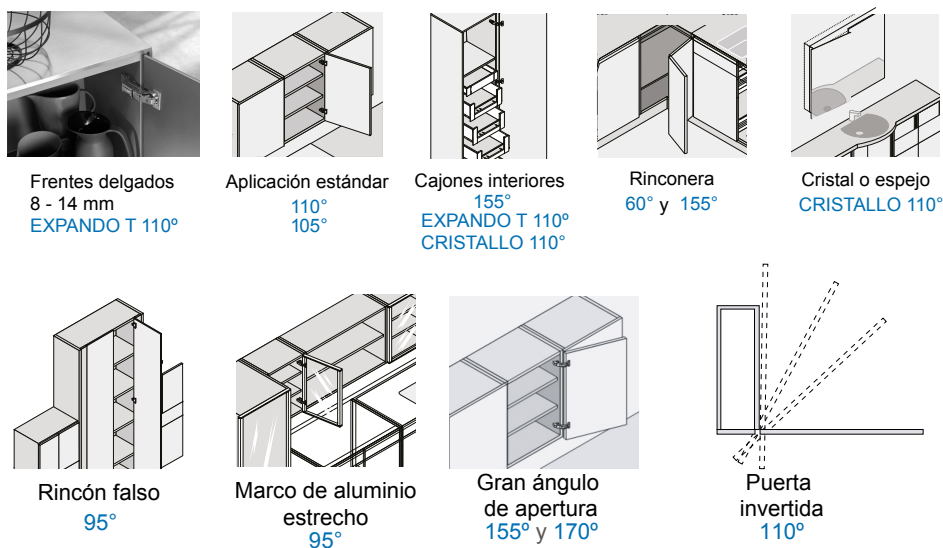

Acabados



Recubrimiento



Bases

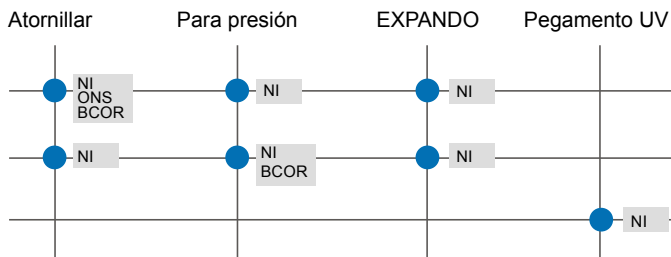

Bisagras negro ónix

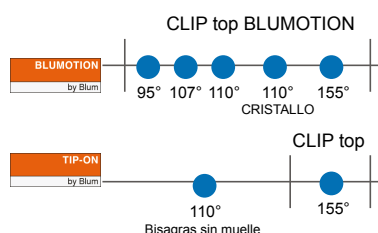

Bisagras BCOR

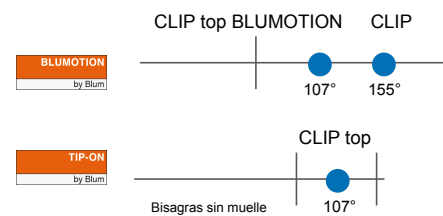
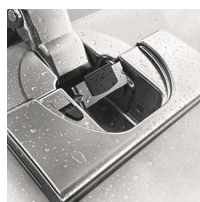

Cómo elegir: Compases abatibles



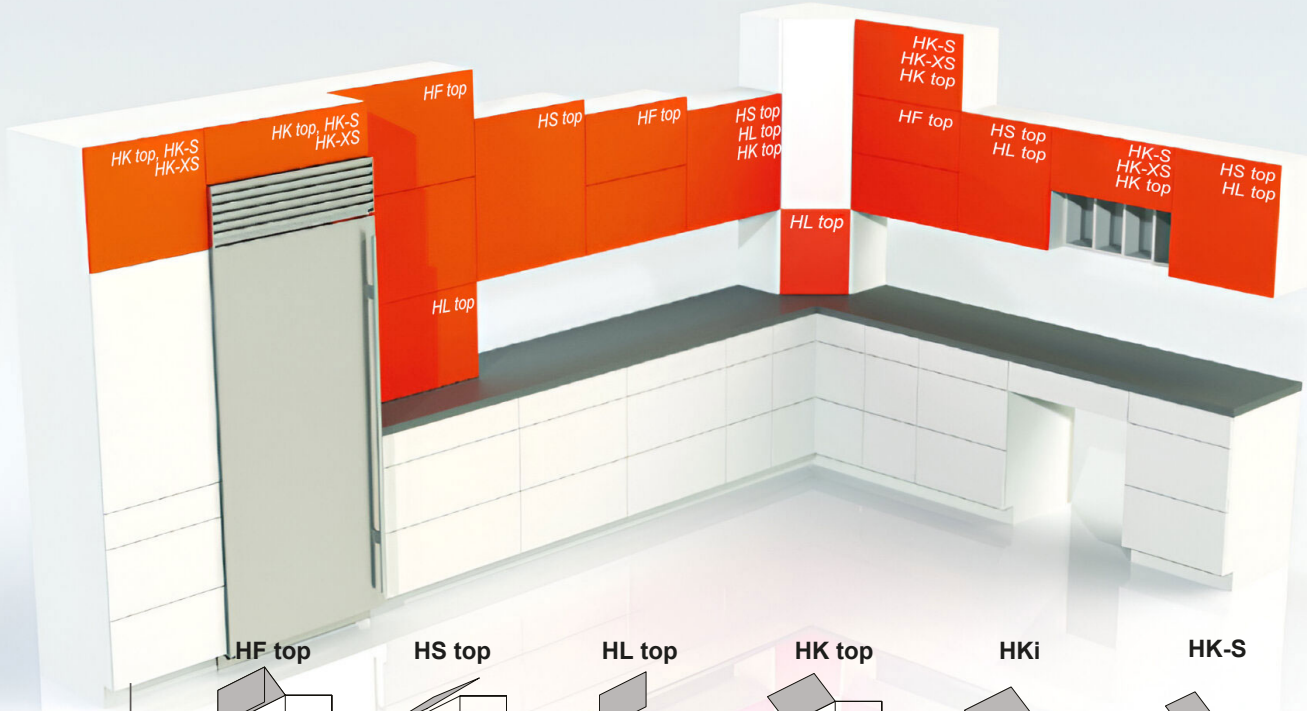







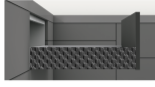



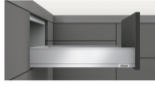





























*La siguiente variedad de productos, corresponden a los herrajes disponibles en Blum México (2026)



1	Tipos de apertura																																						
2																																							
2	<p>Rangos de altura y ancho</p> <table border="1"> <tr> <th>HF top</th> <th>HS top</th> <th>HL top</th> <th>HK top</th> <th>HKi</th> <th>HK-S</th> <th>HK-XS</th> </tr> <tr> <td>480 - 1200 hasta 1200</td> <td>350 - 800 hasta 1200</td> <td>300 - 580 hasta 1200</td> <td>205 - 600 hasta 1200</td> <td>300 - 600 hasta 1200</td> <td>150 - 600 hasta 900</td> <td>240 - 600 hasta 900</td> </tr> </table> <p>Haciendo pruebas logra hasta 1,800 mm</p> <p>Haciendo pruebas logra hasta 1,200 mm</p>							HF top	HS top	HL top	HK top	HKi	HK-S	HK-XS	480 - 1200 hasta 1200	350 - 800 hasta 1200	300 - 580 hasta 1200	205 - 600 hasta 1200	300 - 600 hasta 1200	150 - 600 hasta 900	240 - 600 hasta 900																		
HF top	HS top	HL top	HK top	HKi	HK-S	HK-XS																																	
480 - 1200 hasta 1200	350 - 800 hasta 1200	300 - 580 hasta 1200	205 - 600 hasta 1200	300 - 600 hasta 1200	150 - 600 hasta 900	240 - 600 hasta 900																																	
3	<p>Espacio ocupado arriba del mueble</p> <table border="1"> <tr> <th>HF top</th> <th>HS top</th> <th>HL top</th> <th>HK top</th> <th>HKi</th> <th>HK-S</th> <th>HK-XS</th> </tr> <tr> <td>250 - 492</td> <td>180</td> <td>264 - 529</td> <td>67 - 181</td> <td>67 - 181</td> <td>67 - 181</td> <td>68 - 167</td> </tr> </table> <p>Limitadores de apertura</p> <p>*Consultar en catálogo medida exacta de espacio ocupado.</p> <p>Apertura limitable entre 81° y 116°</p> <p>Apertura limitable entre 75° y 107°</p> <p>Apertura limitable entre 75° y 107°</p> <p>75°</p> <p>86°</p>							HF top	HS top	HL top	HK top	HKi	HK-S	HK-XS	250 - 492	180	264 - 529	67 - 181	67 - 181	67 - 181	68 - 167																		
HF top	HS top	HL top	HK top	HKi	HK-S	HK-XS																																	
250 - 492	180	264 - 529	67 - 181	67 - 181	67 - 181	68 - 167																																	
4	<p>Mecanismo adecuado</p> <p>AVENTOS HF top: Es necesario conocer el peso de ambos frentes con jaladera y la altura total del gabinete</p> <p>AVENTOS HK top*: Es necesario conocer el peso del frente incluido el peso de dos jaladeras y la altura total del gabinete.</p> <p>*Considera esta información para AVENTOS HKi, HK-S y HK-XS.</p>																																						
5	<p>Color de tapas</p> <table border="1"> <tr> <td> </td> <td> </td> <td> </td> <td> </td> <td></td> <td></td> <td></td> </tr> <tr> <td>Gris Oscuro Blanco</td> <td>Gris Oscuro Blanco</td> <td>Gris Oscuro Blanco</td> <td>Gris Oscuro Blanco</td> <td>No Aplica. Mecanismos totalmente ocultos</td> <td>Gris Oscuro</td> <td>No Aplica</td> </tr> </table>														Gris Oscuro Blanco	Gris Oscuro Blanco	Gris Oscuro Blanco	Gris Oscuro Blanco	No Aplica. Mecanismos totalmente ocultos	Gris Oscuro	No Aplica																		
Gris Oscuro Blanco	Gris Oscuro Blanco	Gris Oscuro Blanco	Gris Oscuro Blanco	No Aplica. Mecanismos totalmente ocultos	Gris Oscuro	No Aplica																																	
6	<p>Posibilidades de materiales de frente</p> <table border="1"> <tr> <td></td> <td></td> <td></td> <td></td> <td></td> <td></td> <td></td> </tr> <tr> <td>Madera</td> <td>Marco de aluminio ancho</td> <td>Marco de aluminio estrecho</td> <td>Todos los AVENTOS top</td> <td>Resinas y acrílicos EXPANDO T (8-14mm.) HS top, HL top, HK top</td> <td>Resinas y acrílicos EXPANDO T (8-14mm.) HS top, HL top, HK top</td> <td>Piedra, cerámica, HPL...</td> </tr> </table>														Madera	Marco de aluminio ancho	Marco de aluminio estrecho	Todos los AVENTOS top	Resinas y acrílicos EXPANDO T (8-14mm.) HS top, HL top, HK top	Resinas y acrílicos EXPANDO T (8-14mm.) HS top, HL top, HK top	Piedra, cerámica, HPL...																		
Madera	Marco de aluminio ancho	Marco de aluminio estrecho	Todos los AVENTOS top	Resinas y acrílicos EXPANDO T (8-14mm.) HS top, HL top, HK top	Resinas y acrílicos EXPANDO T (8-14mm.) HS top, HL top, HK top	Piedra, cerámica, HPL...																																	
7	<p>Tecnologías de movimiento</p> <table border="1"> <tr> <th></th> <th>HKi</th> <th>HF top*</th> <th>HS top*</th> <th>HL top*</th> <th>HK top</th> <th>HK-S</th> <th>HK-XS</th> </tr> <tr> <td>BLUMOTION by Blum *BLUMOTION regulable.</td> <td></td> <td></td> <td></td> <td></td> <td></td> <td></td> <td></td> </tr> <tr> <td>Apertura eléctrica SERVO-DRIVE by Blum</td> <td></td> <td></td> <td></td> <td></td> <td></td> <td></td> <td></td> </tr> <tr> <td>Apertura mecánica TIP-ON by Blum</td> <td></td> <td></td> <td></td> <td></td> <td></td> <td></td> <td></td> </tr> </table>								HKi	HF top*	HS top*	HL top*	HK top	HK-S	HK-XS	BLUMOTION by Blum *BLUMOTION regulable.								Apertura eléctrica SERVO-DRIVE by Blum								Apertura mecánica TIP-ON by Blum							
	HKi	HF top*	HS top*	HL top*	HK top	HK-S	HK-XS																																
BLUMOTION by Blum *BLUMOTION regulable.																																							
Apertura eléctrica SERVO-DRIVE by Blum																																							
Apertura mecánica TIP-ON by Blum																																							

Cómo elegir: Sistemas BOX

*La siguiente variedad de productos, corresponden a los herrajes disponibles en Blum México (2026)

Sistema BOX	Altura de cajón	Altura de perfil	Altura máxima de frente de cajón*	Colores disponibles	Largos nominales (mm) y carga dinámica	Cajones interiores	Ancho de cajón*	Accesorios y soluciones funcionales			
LEGRABOX edición especial  Espesor de material para pisos y traseras: 16 mm	Guías BLUMOTION S BLUMOTION, TIP-ON BLUMOTION Y SERVO-DRIVE				40 kg	70 kg					
	 Altura M	90.5 mm	< 300 mm	Color interior del cajón Color exterior del cajón Negro Carbón mate ● Carbon look ● Noble rust ●	500			300 mm de ancho mínimo 1200 mm de ancho máximo	<input checked="" type="checkbox"/> AMBIA-LINE Tapas personalizables para perfil		
	 Altura C	177 mm	< 600 mm						<input checked="" type="checkbox"/> Cajón de tarja		
	 Altura F	241 mm	< 800 mm						<input checked="" type="checkbox"/> Botellero SPACE TWIN <input checked="" type="checkbox"/> SPACE TOWER <input checked="" type="checkbox"/> SPACE STEP		
LEGRABOX pure / free  Espesor de material para pisos y traseras: 16 mm	Guías BLUMOTION S BLUMOTION, TIP-ON BLUMOTION Y SERVO-DRIVE				40 kg	70 kg					
	 Altura M	90.5 mm	< 300 mm	<input type="radio"/> Acero Inoxidable <input type="radio"/> Negro Carbón Mate	400 - 500 - 550	500 - 550	  300 mm de ancho mínimo de cajón  1200 mm de ancho máximo de cajón	Altura C pure y free: Vidrio medio y vidrio completo transparente (piezas de corte) (Espesor: 10 mm) <input checked="" type="checkbox"/> AMBIA-LINE <input checked="" type="checkbox"/> Tapas personalizables para perfil			
	 Altura C pure	177 mm	< 600 mm	<input type="radio"/> Acero Inoxidable <input type="radio"/> Negro Carbón Mate	400 - 500 - 550	500 - 550			<input checked="" type="checkbox"/> Cajón de tarja <input checked="" type="checkbox"/> Botellero SPACE TWIN		
	 Altura C free	177 mm	< 600 mm	<input type="radio"/> Acero Inoxidable <input type="radio"/> Negro Carbón Mate	500	500			<input checked="" type="checkbox"/> SPACE TOWER <input checked="" type="checkbox"/> SPACE STEP		
 Altura F	241 mm	< 800 mm	<input type="radio"/> Acero Inoxidable <input type="radio"/> Negro Carbón Mate	500 - 550	500 - 550	<input checked="" type="checkbox"/> Botellero SPACE TWIN <input checked="" type="checkbox"/> SPACE TOWER <input checked="" type="checkbox"/> SPACE STEP					
MERIVOBX Componentes individuales  Espesor de material para pisos y traseras: 16 mm	Guías con BLUMOTION para TIP-ON BLUMOTION y SERVO-DRIVE				40 kg	70 kg					
	 Altura M	91 mm	< 300 mm	<input type="radio"/> Gris indium mate <input type="radio"/> Blanco seda mate <input type="radio"/> Gris orión mate	400 - 500 - 550		 guardacuerpo transversal elemento de diseño Vidrio medio o vidrio alto (piezas de corte) (espesor 8 mm)	 300 mm de ancho mínimo de cajón  1200 mm de ancho máximo de cajón	Altura E BOXCOVER y BOXCAP: Vidrio medio y vidrio completo transparente (piezas de corte) (Espesor: 8 mm) <input checked="" type="checkbox"/> AMBIA-LINE <input checked="" type="checkbox"/> Tapas personalizables para MERIVOBX <input checked="" type="checkbox"/> Kit de MERIVOBX		
	 Altura E	192 mm perfil M + guardacuerpo	< 800 mm							<input checked="" type="checkbox"/> Cajón de tarja <input checked="" type="checkbox"/> Botellero SPACE TWIN	
	 Altura E	192 mm perfil M + BOXCAP	< 800 mm							<input checked="" type="checkbox"/> SPACE TOWER <input checked="" type="checkbox"/> SPACE STEP	
 Altura E	192 mm perfil M + BOXCOVER	< 800 mm									
KIT de MERIVOBX  Espesor de material para pisos y traseras: 16 mm *Elementos de diseño se venden por separado (Guardacuerpos, BOXCOVER y/o BOXCAP)	Guías con BLUMOTION para TIP-ON BLUMOTION y SERVO-DRIVE				40 kg	70 kg					
	 Altura M	91 mm	< 300 mm	<input type="radio"/> Gris indium mate <input type="radio"/> Blanco seda mate <input type="radio"/> Gris orión mate	500		No aplica	 guardacuerpo transversal elemento de diseño Vidrio medio o vidrio alto (piezas de corte) (espesor 8 mm)	 300 mm de ancho mínimo de cajón  1200 mm de ancho máximo de cajón	Altura E BOXCOVER y BOXCAP: Vidrio medio y vidrio completo transparente (piezas de corte) (Espesor: 8 mm) <input checked="" type="checkbox"/> AMBIA-LINE <input checked="" type="checkbox"/> Tapas personalizables para MERIVOBX <input checked="" type="checkbox"/> Kit de MERIVOBX	
	 Altura E	192 mm perfil M + guardacuerpo	< 800 mm								<input checked="" type="checkbox"/> Cajón de tarja <input checked="" type="checkbox"/> Botellero SPACE TWIN
	 Altura E	192 mm perfil M + BOXCAP	< 800 mm								<input checked="" type="checkbox"/> SPACE TOWER <input checked="" type="checkbox"/> SPACE STEP
 Altura E	192 mm perfil M + BOXCOVER	< 800 mm									
TANDEMBOX antaro  Espesor de material para pisos y traseras: 16 mm	Guías con BLUMOTION para TIP-ON BLUMOTION y SERVO-DRIVE				30 kg	65 kg					
	 Altura M	83.5 mm	< 300 mm	Gris ●	500		  300 mm de ancho mínimo de cajón  1200 mm de ancho máximo de cajón	<input checked="" type="checkbox"/> ORGA-LINE <input checked="" type="checkbox"/> Tapas personalizables para perfil			
	 Altura C	172.3 mm perfil M + guardacuerpo	< 500 mm						<input checked="" type="checkbox"/> Cajón de tarja <input checked="" type="checkbox"/> Botellero SPACE TWIN		
 Altura D	204.3 mm perfil M + guardacuerpo	< 600 mm	<input checked="" type="checkbox"/> SPACE TOWER <input checked="" type="checkbox"/> SPACE STEP								
METABOX  Espesor de material para pisos y traseras: 16 mm	Guías METABOX BLUMOTION como accesorio adicional				25 kg						
	 Altura M	86 mm	< 250 mm	<input type="radio"/> Gris <input type="radio"/> Blanco nieve	400 - 500 - 550		  300 mm de ancho mínimo de cajón  800 mm de ancho máximo de cajón	<input checked="" type="checkbox"/> Separadores transversales de cajón altura B y D <input checked="" type="checkbox"/> Tapas personalizables para perfil <input checked="" type="checkbox"/> BOXSIDE para cajón altura D *sobre pedido			
	 Altura K	118 mm	< 400 mm	<input type="radio"/> Blanco nieve	500	<input checked="" type="checkbox"/> Cajón de tarja <input checked="" type="checkbox"/> Botellero SPACE TWIN					
	 Altura B	143 mm perfil M + guardacuerpo	< 500 mm	<input type="radio"/> Gris <input type="radio"/> Blanco nieve	400 - 500 - 550	<input checked="" type="checkbox"/> SPACE TOWER <input checked="" type="checkbox"/> SPACE STEP					
	 Altura H	150 mm	< 500 mm	<input type="radio"/> Gris <input type="radio"/> Blanco nieve	400 - 500						
 Altura D	207 mm perfil M + guardacuerpo	< 500 mm	<input type="radio"/> Gris <input type="radio"/> Blanco nieve	400 - 500 - 550	<input checked="" type="checkbox"/> Botellero SPACE TWIN <input checked="" type="checkbox"/> SPACE TOWER <input checked="" type="checkbox"/> SPACE STEP						

* Recomendación

Cómo elegir: Sistemas de guías

*La siguiente variedad de productos, corresponden a los herrajes disponibles en Blum México (2026)

Guías	Extensión	Largo nominal y Carga dinámica	Ancho máximo de cajón*	Soluciones funcionales	Accesorios																																																				
MOVENTO 	<p>TOTAL</p>	<p>GUÍAS BLUMOTION S*</p> <table border="1"> <thead> <tr> <th>NL</th> <th>40 Kg</th> <th>60 Kg</th> <th>70 Kg</th> </tr> </thead> <tbody> <tr><td>300</td><td>✓</td><td>✗</td><td>✓</td></tr> <tr><td>350</td><td>✓</td><td>✗</td><td>✗</td></tr> <tr><td>400</td><td>✓</td><td>✗</td><td>✗</td></tr> <tr><td>450</td><td>✓**</td><td>✗</td><td>✗</td></tr> <tr><td>500</td><td>✓**</td><td>✗</td><td>✓</td></tr> <tr><td>550</td><td>✓</td><td>✗</td><td>✓</td></tr> <tr><td>600</td><td>✗</td><td>✗</td><td>✓</td></tr> <tr><td>650</td><td>✗</td><td>✗</td><td>✓</td></tr> <tr><td>700</td><td>✗</td><td>✓</td><td>✗</td></tr> </tbody> </table> <p>Sirve para BLUMOTION, TIP-ON BLUMOTION y SERVO DRIVE.</p>	NL	40 Kg	60 Kg	70 Kg	300	✓	✗	✓	350	✓	✗	✗	400	✓	✗	✗	450	✓**	✗	✗	500	✓**	✗	✓	550	✓	✗	✓	600	✗	✗	✓	650	✗	✗	✓	700	✗	✓	✗	<p>< 1200 mm</p> <p><small>*Medida máxima sugerida, se recomienda hacer pruebas</small></p>	<table border="1"> <tbody> <tr><td>Cajón de tarja</td><td>✓</td></tr> <tr><td>Botellero SPACE TWIN</td><td>✓</td></tr> <tr><td>SPACE TOWER</td><td>✓</td></tr> <tr><td>SPACE STEP</td><td>✓</td></tr> <tr><td>Tope de repisa</td><td>✓</td></tr> <tr><td>Guía sobre piso</td><td>✓</td></tr> </tbody> </table>	Cajón de tarja	✓	Botellero SPACE TWIN	✓	SPACE TOWER	✓	SPACE STEP	✓	Tope de repisa	✓	Guía sobre piso	✓	<p>Organización</p> <ul style="list-style-type: none"> ORGA-LINE AMBIA-LINE <p>TIP-ON BLUMOTION</p> <ul style="list-style-type: none"> Kit TIP-ON BLUMOTION Varilla de sincronización <p>TIP-ON</p> <ul style="list-style-type: none"> Juego de piñones Varilla de TIP-ON
		NL	40 Kg	60 Kg	70 Kg																																																				
300	✓	✗	✓																																																						
350	✓	✗	✗																																																						
400	✓	✗	✗																																																						
450	✓**	✗	✗																																																						
500	✓**	✗	✓																																																						
550	✓	✗	✓																																																						
600	✗	✗	✓																																																						
650	✗	✗	✓																																																						
700	✗	✓	✗																																																						
Cajón de tarja	✓																																																								
Botellero SPACE TWIN	✓																																																								
SPACE TOWER	✓																																																								
SPACE STEP	✓																																																								
Tope de repisa	✓																																																								
Guía sobre piso	✓																																																								
TANDEM 	<p>TOTAL</p>	<p>GUÍAS BLUMOTION</p> <table border="1"> <thead> <tr> <th>NL</th> <th>30 Kg</th> </tr> </thead> <tbody> <tr><td>300</td><td>✓</td></tr> <tr><td>350</td><td>✓</td></tr> <tr><td>400</td><td>✓</td></tr> <tr><td>450</td><td>✓</td></tr> <tr><td>500</td><td>✓</td></tr> <tr><td>550</td><td>✓</td></tr> </tbody> </table>	NL	30 Kg	300	✓	350	✓	400	✓	450	✓	500	✓	550	✓	<p>< 1200 mm</p> <p><small>*Medida máxima sugerida, se recomienda hacer pruebas</small></p>	<table border="1"> <tbody> <tr><td>Cajón de tarja</td><td>✓</td></tr> <tr><td>Botellero SPACE TWIN</td><td>✓</td></tr> <tr><td>SPACE TOWER</td><td>✓</td></tr> <tr><td>SPACE STEP</td><td>✓</td></tr> <tr><td>Tope de repisa</td><td>✓</td></tr> <tr><td>Guía sobre piso</td><td>✗</td></tr> </tbody> </table>	Cajón de tarja	✓	Botellero SPACE TWIN	✓	SPACE TOWER	✓	SPACE STEP	✓	Tope de repisa	✓	Guía sobre piso	✗	<p>Organización</p> <ul style="list-style-type: none"> ORGA-LINE AMBIA-LINE <p>TIP-ON BLUMOTION</p> <ul style="list-style-type: none"> Kit TIP-ON BLUMOTION Varilla de sincronización <p>TIP-ON</p> <ul style="list-style-type: none"> Varilla de TIP-ON Juego de piñones 																										
		NL	30 Kg																																																						
300	✓																																																								
350	✓																																																								
400	✓																																																								
450	✓																																																								
500	✓																																																								
550	✓																																																								
Cajón de tarja	✓																																																								
Botellero SPACE TWIN	✓																																																								
SPACE TOWER	✓																																																								
SPACE STEP	✓																																																								
Tope de repisa	✓																																																								
Guía sobre piso	✗																																																								
<p>PARCIAL</p>	<p>GUÍAS BLUMOTION</p> <table border="1"> <thead> <tr> <th>NL</th> <th>30 Kg</th> </tr> </thead> <tbody> <tr><td>400</td><td>✓</td></tr> <tr><td>450</td><td>✓</td></tr> <tr><td>500</td><td>✓</td></tr> <tr><td>550</td><td>✓</td></tr> </tbody> </table>	NL	30 Kg	400	✓	450	✓	500	✓	550	✓	<p><small>*Medida máxima sugerida, se recomienda hacer pruebas</small></p>	<table border="1"> <tbody> <tr><td>Cajón de tarja</td><td>✓</td></tr> <tr><td>Botellero SPACE TWIN</td><td>✓</td></tr> <tr><td>SPACE TOWER</td><td>✓</td></tr> <tr><td>SPACE STEP</td><td>✗</td></tr> <tr><td>Tope de repisa</td><td>✗</td></tr> <tr><td>Guía sobre piso</td><td>✗</td></tr> </tbody> </table>	Cajón de tarja	✓	Botellero SPACE TWIN	✓	SPACE TOWER	✓	SPACE STEP	✗	Tope de repisa	✗	Guía sobre piso	✗	<p>Organización</p> <ul style="list-style-type: none"> ORGA-LINE AMBIA-LINE 																															
	NL	30 Kg																																																							
400	✓																																																								
450	✓																																																								
500	✓																																																								
550	✓																																																								
Cajón de tarja	✓																																																								
Botellero SPACE TWIN	✓																																																								
SPACE TOWER	✓																																																								
SPACE STEP	✗																																																								
Tope de repisa	✗																																																								
Guía sobre piso	✗																																																								
TANDEM 7/8 <p>7/8</p>	<p>GUÍAS BLUMOTION</p> <p>*Programa con acoplamiento y para encastrar</p> <table border="1"> <thead> <tr> <th>NL</th> <th>SKL*</th> <th>25 Kg</th> </tr> </thead> <tbody> <tr><td>435</td><td>400</td><td>✓</td></tr> <tr><td>485</td><td>450</td><td>✓</td></tr> <tr><td>530</td><td>500</td><td>✓</td></tr> </tbody> </table> <p><small>*Largo de cajón</small></p>	NL	SKL*	25 Kg	435	400	✓	485	450	✓	530	500	✓	<p>< 800 mm</p> <p><small>*Medida máxima sugerida, se recomienda hacer pruebas</small></p>	<table border="1"> <tbody> <tr><td>Cajón de tarja</td><td>✓</td></tr> <tr><td>Botellero SPACE TWIN</td><td>✓</td></tr> <tr><td>SPACE TOWER</td><td>✓</td></tr> <tr><td>SPACE STEP</td><td>✗</td></tr> <tr><td>Tope de repisa</td><td>✗</td></tr> <tr><td>Guía sobre piso</td><td>✗</td></tr> </tbody> </table>	Cajón de tarja	✓	Botellero SPACE TWIN	✓	SPACE TOWER	✓	SPACE STEP	✗	Tope de repisa	✗	Guía sobre piso	✗	<p>Organización</p> <ul style="list-style-type: none"> ORGA-LINE AMBIA-LINE 																													
NL	SKL*	25 Kg																																																							
435	400	✓																																																							
485	450	✓																																																							
530	500	✓																																																							
Cajón de tarja	✓																																																								
Botellero SPACE TWIN	✓																																																								
SPACE TOWER	✓																																																								
SPACE STEP	✗																																																								
Tope de repisa	✗																																																								
Guía sobre piso	✗																																																								

Cómo elegir: **AMBIA-LINE**

*La siguiente variedad de productos, corresponden a los herrajes disponibles en Blum México (2026)
 La siguiente información corresponde a los sistemas de organización disponibles para cajones de 500 mm de largo nominal (NL).

Acabados

- SW-M** - Blanco Seda Mate
- OG-M** - Gris Orión Mate
- CS-M** - Negro Carbón Mate
- E02G** - Roble Nebraska
- N01T** - Nogal Tennessee
- IG-M** - Gris Indium Mate

**Todas las medidas están expresadas en mm (largo x ancho x alto)

	AMBIA-LINE Metal	AMBIA-LINE Madera	Organizadores AMBIA-LINE
Bandejas, separadores y contenedores	<p>B3 Bandeja de 6 compartimentos Medidas en mm: 474x300x50 ZC7S500BS3</p> <p>S1 Separador estrecho Medidas en mm: 474x100x50 ZC7S500RS1</p> <p>S2 Separador ancho Medidas en mm: 474x200x50 ZC7S500RS2</p> <p>S3 Separador alto Medidas en mm: 370x218x110 ZC7F400RSP</p>	<p>B3 Bandeja de 6 compartimentos Medidas en mm: 474x300x50 ZC7S500BH3</p> <p>C1 Contenedor estrecho Medidas en mm: 474x100x50 ZC7S500BH1</p> <p>C2 Contenedor ancho Medidas en mm: 474x200x50 ZC7S500BH2</p> <p>C3 Contenedor alto Medidas en mm: 370x218x110 ZC7F400RSP</p>	<p>1 Porta cuchillos (Para separador S2 y contenedor C2) ZC7M0200</p> <p>2 Organizador vertical (Para separador S3 y contenedor C3) ZC7G0P0I</p> <p>1 Cortador de plástico y aluminio (Para separador S2 y contenedor C2) ZC7C000</p> <p>Soporte para platos ZC7T0350</p>

Otros accesorios

- Set botellero para S2**
ZC7B0200S
LEGRABOX/MERIVOBX

Adaptador de divisor longitudinal
ZC7U10E0 LEGRABOX

Separador transversal para cortar a medida
Medidas en mm: 1080 de largo
ZR7.1080U
LEGRABOX/MERIVOBX

Divisor longitudinal
ZC7U10F0 LEGRABOX

Divisor longitudinal
ZC4U10F0 MERIVOBX

ZC4U10E0 MERIVOBX

ZC4U11E0 MERIVOBX para elemento de vidrio

Cómo elegir: ORGA-LINE

*La siguiente variedad de productos, corresponden a los herrajes disponibles en Blum México (2026)
La siguiente información corresponde a los sistemas de organización disponibles para cajones de 500 mm de largo nominal (NL).

Acabados



Acero inox / gris polvo IG/G



Gris (R906)



Blanco Seda (SEIW)

Sistema BOX

TANDEMBOX antaro

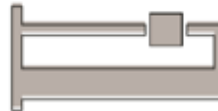

Altura



Altura M
(83.6 mm)

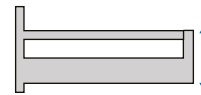

Altura C
(172.3 mm)

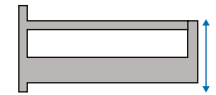

Altura D
(204.3 mm)

Programa

Cubertero
ZSI.500B11

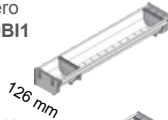

Cubertero
ZSI.500B13

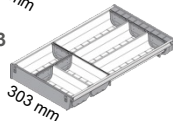

Cubertero y divisor
con un separador ind.
ZSI.500K14

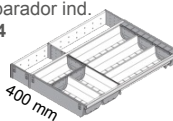

Divisor con
un separador ind.
ZSI.500F11

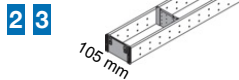

Divisor con un separador
ind. **ZSI.500F12**

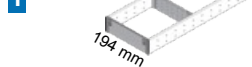

Alojamiento separador
transversal
Altura D
Z40D0002Z

Separador longitudinal
Z43L100S

Alojamiento
separador transversal
para tabique de separación
Z40L0002

Tabique de separación
Z46L470S

Bandeja para botellas
Z48.30B016

Alojamiento
separador transversal
Altura C
Z40C0002Z

Separador transversal
para cortar a medida
Z40L1077A

Alojamiento separador
transversal
Altura D
Z40D0002Z

Accesorios de cocina

1 Porta cuchillos
para divisor F12
ZSZ.02M0

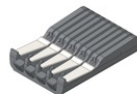

2 Cortador de plástico
ZSZ.01F0

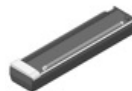

3 Cortador de aluminio
ZSZ.02F0

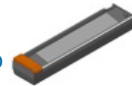

Soporte para platos
ZC7T0350

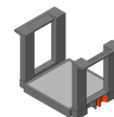

Organizador vertical
ZFZ.30G01
ZFZ.40G01
ZFZ.45G01



Cómo elegir: REVEGO OPTIMIZADO

*La siguiente variedad de productos, corresponden a los herrajes disponibles en Blum México (2026)

Conoce REVEGO



Concepto



Ajuste y montaje



Conoce más

Configuraciones

REVEGO uno



Izquierda



Derecha

REVEGO duo



Izquierda



Derecha

Medidas generales del pocket

Se recomienda utilizar materiales de 18 - 19 mm de espesor para la construcción del pocket

Nuevos productos disponibles en Blum México

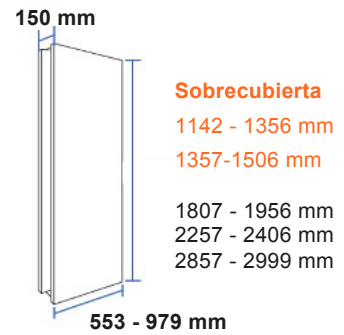
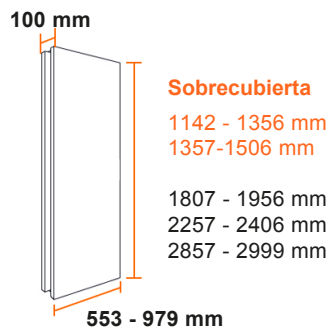

Dimensiones del frente

*La altura del frente variará en función de la altura del pocket que se elija..

Nuevas alturas disponibles

Número de frentes	1	Número de frentes	2
Ancho de frente	442- 898 mm	Ancho de frente	442- 748 mm
*Alto de frente	1139 - 1353 mm 1354 - 1503 mm 1800 - 1949 mm 2250 - 2399 mm 2850 - 2972 mm	*Alto de frente	1139 - 1353 mm 1354 - 1503 mm 1800 - 1949 mm 2250 - 2399 mm 2850 - 2972 mm
Espesor de frente	18 - 26 mm	Espesor de frente	18 - 26 mm
Peso máx. por frente	35 kg	Peso máx. por frente	35 kg
Materiales para el frente	<ul style="list-style-type: none"> ● Madera ● MDF ● Aglomerados ● MDP 	Materiales para el frente	<ul style="list-style-type: none"> ● Madera ● MDF ● Aglomerados ● MDP

Cubrimiento* del frente

*Con REVEGO se puede cubrir hasta 19 mm del costado exterior del pocket

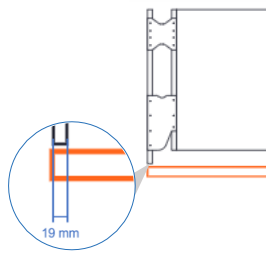

Vista superior

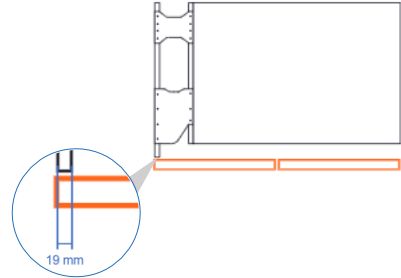

Vista superior

Posibles combinaciones

- *REVEGO duo + duo
- *REVEGO uno + duo
- REVEGO uno + uno
- REVEGO duo/
REVEGO duo sobrecubierta
- REVEGO uno /
REVEGO uno sobrecubierta

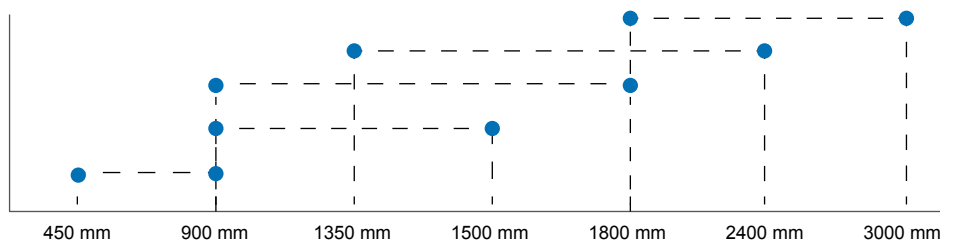

Dimensiones de ancho total de instalación

*En caso de realizar la combinación de REVEGO uno+duo / REVEGO duo+duo es necesario agregar la extensión de riel en el listado de herrajes a solicitar

⚠ Es importante colocar el herraje del pocket y frentes de REVEGO con tornillo EURO (No. Art: 661.1450.HG)

Planifica REVEGO

Se recomienda utilizar Máquina CNC para perforación de cara y canto para mecanizar las piezas de madera.



Especifica tu proyecto con REVEGO fácilmente usando el Configurador de productos Blum y obtén el listado de herrajes, maquinado y mucho más.

¿Necesitas fotografías de alta calidad o datos CAD para tus proyectos con REVEGO? Da clic aquí y conoce nuestros Servicios digitales, disponibles sin costo.

Cómo elegir: Productos Personalizables

*La siguiente variedad de productos, corresponden a los herrajes disponibles en Blum México (2026)

De igual modo el programa mostrado a continuación corresponde a la gama de productos personalizados en Blum Austria, por lo que todo se encontrará bajo pedido (IC6)

	Familia de producto	Acabado de perfil para personalizar	Técnica de personalización	Sugerencia de personalización	Cantidad mínima	Tiempo de entrega		
				<ul style="list-style-type: none"> Impresión de detalle o logotipo. Cualquier color o combinación. 	240 pzas	Perfiles personalizados 18 semanas		
								<ul style="list-style-type: none"> Cubre la totalidad del perfil Dimensiones definidas por el cliente Cualquier color o combinación.
				<ul style="list-style-type: none"> Grabado láser de detalle o logotipo Tamaño máximo de 70.7mm de ancho x 30mm de alto. 				
	Familia de producto	Acabados en tapas lisas	Técnica de personalización			Cantidad mínima	Tiempo de entrega	
			Color sólido	Personalizado	Metálica	Troquelado		
	LEGRABOX			Colores especiales (Selección del cliente hasta 4 colores)		<input checked="" type="checkbox"/>	Impresión 1,000 pzas Troquelado 5,000 pzas	Impresión 14 semanas Troquelado 18 semanas
	MERIVOBX & AVENTOS					<input checked="" type="checkbox"/>	Troquelado 5,000 pzas Acabado cepillado + troquelado 8,000 pzas	
	TANDEMBOX antaro				N/A	<input checked="" type="checkbox"/>	Impresión 1,000 pzas Troquelado 12,000 pzas	
	METABOX				N/A	<input checked="" type="checkbox"/>	Impresión 1,000 pzas	
	BISAGRA 110° (CLIP top BLUMOTION, CLIP top y CLIP)				N/A	<input checked="" type="checkbox"/>	Impresión 1,000 pzas	
	BISAGRA medio codo (CLIP top BLUMOTION, CLIP top y CLIP)				N/A	<input checked="" type="checkbox"/>	Troquelado 25,000 pzas	
	BISAGRA 155° (EXPANDO, CRISTALLO, CLIP top BLUMOTION y CLIP top)				N/A	<input checked="" type="checkbox"/>	Impresión 1,000 pzas	
	BISAGRA brazo recto (MODUL, CLIP top y CLIP)				N/A	<input checked="" type="checkbox"/>	Impresión 1,000 pzas Troquelado 20,000 pzas	

 **blum**®

Inscríbete a nuestro NEWSLETTER
dando clic aquí

Síguenos en:



@blummexico



Blum México



@blumBMX